



MEMO Timer

User manual

Art. nr: 500150 500155 500160 500165

Product use

MEMO Timer counts down the selected time interval by means of illuminated dots in a time pillar. When all dots have gone black, time is up and the alarm will sound.

MEMO Timer is a visual timer that is intended for people who need support in understanding the length and passage of time. It is water proof and made for indoor as well as outdoor use. The estimated lifetime for this product is 5 years. MEMO Timer is durable and can withstand being dropped during normal use.

About MEMO Timer

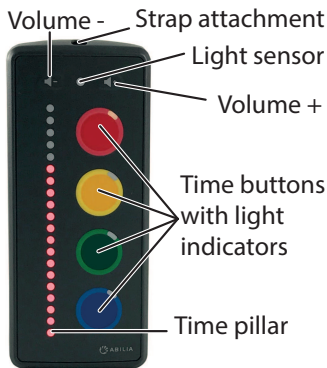

The time buttons on the different models correspond to different timer intervals in minutes.

Time button	MEMO Timer			
	8	20	60	80
Blue	2	5	15	20
Green	4	10	30	40
Yellow	6	15	45	60
Red	8	20	60	80

The light sensor adapts the brightness of the dots to the surrounding light. By using the provided straps, MEMO Timer can be carried around the neck or hung, for example, on a hook or in the shower.



WARNING: Only use the provided straps with security buckle to avoid choking and other injuries.

Get started with MEMO Timer

Fit the selected strap if desired.

Fit the batteries according to step 1-7:

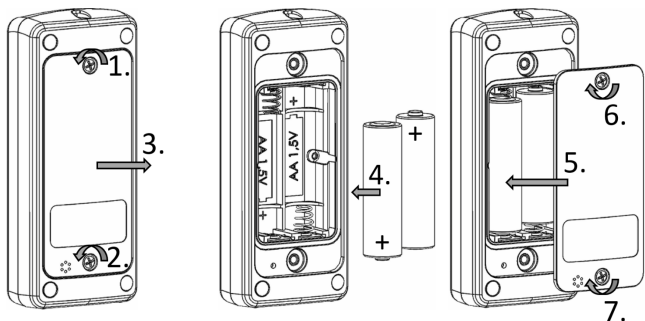

Always make sure that the seal of the battery lid is undamaged and free from debris before the lid is put back in place. Instruct the user on how to use the product in a safe way.

Maintenance and cleaning

When it is time to change the batteries, there will be an audible signal every hour. See *Get started with MEMO Timer* for how to change the batteries.











Clean the product with warm water and soap, using a soft cloth.

Functions and settings

● = Simultaneously push and hold down the indicated time buttons.

The default settings are indicated in ***bold italic***.

Function	Buttons	Information
Start timer	Press and release the time button that corresponds to the requested time interval.	<p>The corresponding number of dots light up.</p> <p>The indicator on the selected button lights up (if setting = 'Button lights on').</p> <p>When time is out, the alarm sets off with a flashing time pillar and with signal and vibration according to settings.</p>
Stop alarm	Press and release any button.	The alarm is stopped.
Cancel countdown	● + ● 2 sec	The countdown is interrupted.
Adjust alarm volume	Press and release Volume +/- to increase and decrease the alarm volume.	<p>Volume in five steps. 1=silent, 5=max (default setting=<i>3</i>).</p> <p>A sample signal sounds at each step.</p> <p>A vibration announces step 1 and step 5.</p>

Setting	Buttons	Information			
Change alarm signal	 2 sec	Use Volume +/- to change. A sample signal sounds at each step.	Alarm 1	Alarm 2	Alarm 3
Vibration	 2 sec	Use Volume +/- to change.	Off	On	On in silent mode
Button lights	 2 sec	Use Volume +/- to change.	Off	On	
Max brightness	 2 sec	Brightness in five steps. 1=min, 5=max (default setting = 3). Use Volume +/- to change. The set brightness is shown at each step.			
Leave setting mode		Illuminated dots flash 3 times. Alternatively, wait for 10 seconds.			
Keylock	 See info*	Locked = Time pillar flashes once. Only "start timer" and "stop alarm" possible. Unlocked = Time pillar flashes twice.			
Reset	 2 sec	Reset to default settings.			

* Push and hold down the blue button while sequentially pushing and releasing the green, yellow and red buttons.

What's in the box

- 1 x MEMO Timer
- 1 x Neck strap
- 1 x Short strap
- 2 x AA batteries 1,5 V
- User manual (this document)

Product specifications

Dimensions H x W x D:	107 x 46 x 25 mm
Weight:	0.12 kg
Battery:	2 x AA 1,5 V
Alarm volume:	max 80 dB (1 meter)
IP code:	IP67
Temperature range:	-10°C to +40°C

Storage and disposal

Remove the batteries before storing the product for a long period.



The product contains electrical components that must be recycled. Dispose the product at an applicable disposal location.

Conformance with requirements for medical devices

MEMO Timer is marketed as a technical aid for people with disabilities. It complies with all necessary requirements, regulations and directives for medical devices.

Important information

 **WARNING:** Read the following warning instructions before you use the product.

- Before you use the product, read and understand the contents of this user manual.
- Only use the provided straps with security buckle to avoid choking and other injuries.

Serious incidents

If a serious incident related to the product occurs, report this to the manufacturer and the competent authority of your country. A serious incident directly or indirectly led, might have led or might lead to the death of a patient, user or other person; the temporary or permanent serious deterioration of a patient's, user's or other person's state of health; or a serious public health threat.

Product liability

The product is developed and risk-assessed according to ISO 14971 and EN 12182. The manual and the technical specifications are made according to the safety assessments in the risk analysis. Always consider the safety when using the product. Abilia AB does not take responsibility for any consequences following incorrect use or installation of the product. Any form of damage or tampering with the product invalidates the warranty and disclaims the manufacturer's liability. The estimated life of the product applies when used in accordance with its intended use and maintenance instructions.

For more information about the product and the latest version of this document, go to www.abilia.com/en.



500150 500155 500160 500165_ User manual_ MEMO Timer_ EN December 2021



Abilia AB, Råsundavägen 6, 169 67 Solna, Sweden
Phone +46 (0)8- 594 694 00 | info@abilia.com | www.abilia.com



ABILIA